



DCA70SSIU4F

MQ POWER Series Generator

WhisperWatt™

Prime Rating — 56 kW (70 kVA)

Standby Rating — 62 kW (77 kVA)

3-Phase, 60 Hertz, 0.8 PF

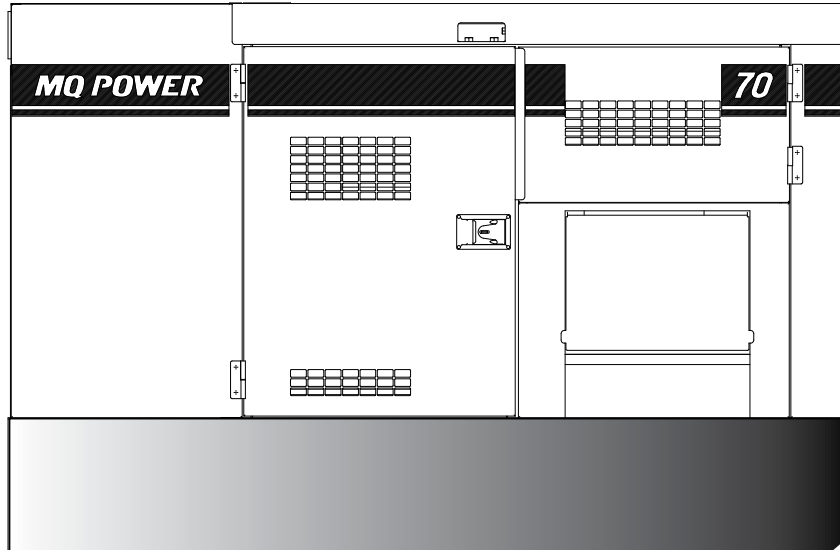

STANDARD FEATURES

- Heavy duty, 4-cycle, direct injection, turbocharged, charge air cooled diesel engine provides maximum reliability.
- Brushless alternator reduces service and maintenance requirements and meets temperature rise standards for Class H insulation systems.
 - Open delta alternator design provides virtually unlimited excitation for maximum motor starting capability.
 - Automatic voltage regulator (AVR) provides precise regulation.
- Electronic governor system maintains frequency to $\pm 0.25\%$.
- Full load acceptance of standby nameplate rating in one step (NFPA 110, para 5.6.3.1.2).
- Sound attenuated, weather resistant, steel housing provides operation at 65 dB(A) at 23 feet. Fully lockable enclosure allows safe unattended operation.
- Internal fuel tank with direct reading fuel gauge.
- E-coat and powder coat paint provide durability and weather protection.
- Digital engine gauges including oil pressure, water temperature, battery volts, engine speed, and fuel level.
- Analog generator instrumentation including AC ammeter, AC voltmeter, frequency meter, ammeter phase selector switch, voltmeter phase selector switch, and voltage regulator adjustment potentiometer.
- ECU835 microprocessor-based digital generator controller.
 - Remote 2-wire start/stop control.
 - Operational temperature range of -40° to 85° C.
 - High visibility LCD display with heated screen and alphanumeric readout.
 - Modbus interface for gauge panel and expansion options.
- Automatic safety shutdown system monitors the water temperature, engine oil pressure, overspeed, and overcrank. Warning lights indicate abnormal conditions.
- Fully covered power panel. Three-phase terminals and single phase receptacles allow fast and convenient hookup for most applications including temporary power boxes, tools and lighting equipment. All are NEMA standard.
- Voltage selector switch offers the operator a wide range of voltages that are manually selectable. Fine tuning of the output voltage can be accomplished by adjusting the voltage regulator control knob to obtain the desired voltage.
- Fuel/water separator. Removes condensation from fuel for extended engine life. Panel mounted alarm light included.
- Crankcase vent heater.
- Simultaneous single and three phase power.
- EPA emissions certified - Tier 4 Final emissions compliant.
 - Engine fitted with DOC and SCR.
- Spill Containment - Bunded design protects environment by capturing up to 128% of engine fluids.



DCA70SSIU4F

MQ POWER Series Generator

SPECIFICATIONS

Generator Specifications		
Design	Revolving field, self-ventilated Drip-proof, single bearing	
Armature Connection	Star with Neutral	Zig Zag
Phase	3	Single
Standby Output	62 KW (77 KVA)	44 KW
Prime Output	56 KW (70 KVA)	40 KW
3Ø Voltage (L-L/L-N) Voltage Selector Switch at 3Ø 240/139	208Y/120, 220Y/127, 240Y/139	N/A
3Ø Voltage (L-L/L-N) Voltage Selector Switch at 3Ø 480/277	416Y/240, 440Y/254, 480Y/277	N/A
1Ø Voltage (L-L/L-N) (Voltage Selector Switch at 1Ø 240/120)	N/A	240/120
Power Factor	0.8	1.0
Voltage Regulation (No load to full load)	±0.5%	
Generator RPM	1800	
Frequency	60 Hz	
No. of Poles	4	
Excitation	Brushless with AVR	
Frequency	60 Hz	
Frequency Regulation: No Load to Full Load	Isochronous under varying loads from no load to 100% rated load	
Frequency Regulation: Steady State	±0.25% of mean value for constant loads from no load to full load.	
Insulation	Class H	
Sound Level dB(A) Full load at 23 feet	65	

Engine Specifications	
Make / Model	Isuzu / BR-4JJ1X
Emissions	EPA Tier 4 Final Certified
Starting System	Electric
Design	4-cycle, water cooled, direct injection, turbocharged, charge air cooled, DOC and SCR
Displacement	183.0 in ³ (2999 cc)
No. cylinders	4
Bore x Stroke (mm)	95.4 x 104.9
Gross Engine Power Output	95.2 hp (71 kW)
BMEP	208 psi (1434 kPa)
Piston Speed	1237 ft./min. (6.29 m/s)
Compression Ratio	16.5:1
Engine Speed	1800 rpm
Overspeed Limit	2070 rpm
Oil Capacity	3.96 gallons (15 liters)
Battery	12V 75Ah x 1

Fuel System		
Recommended Fuel	ASTM-D975-No.1 & No.2-D*	
Maximum Fuel Flow (per hour)	16 gallons (60 liters)	
Maximum Inlet Restriction (Hg)	2.9 in. (73.6 mm)	
Fuel Tank Capacity	103 gallons (390 liters)	
Fuel Consumption	gph	lph
At full load	4.4	16.6
At 3/4 load	3.5	13.4
At 1/2 load	2.6	9.8
At 1/4 load	1.7	6.4
DEF Tank Capacity	7.4 gallons (28 liters)	

* - Use ultra-low sulfur diesel fuel.

Cooling System	
Fan Load	4.7 hp (3.5 kW)
Coolant Capacity (with radiator)	5.5 gallons (21 liters)
Coolant Flow Rate (per minute)	15.9 gallons (60 liters)
Heat Rejection to Coolant (per minute)	2483 Btu (2.62 MJ)
Maximum Coolant Friction Head	1.2 psi (7.9 kPa)
Maximum Coolant Static Head	3.3 feet (1.0 meter)
Ambient Temperature Rating	104°F (40°C)

Air	
Combustion Air	138 cfm (3.9 m ³ /min)
Maximum Air Cleaner Restriction	25 in. H ₂ O (6.25 kPa)
Alternator Cooling Air	526 cfm (14.9 m ³ /min)
Radiator Cooling Air	3700 cfm (105 m ³ /min)
Minimum Air Opening to Room	6.03 ft ² (0.56 m ²)
Minimum Discharge Opening	3.33 ft ² (0.31 m ²)

Exhaust System	
Gas Flow (full load)	272 cfm (7.7 m ³ /min)
Gas Temperature	572°F (300°C)
Maximum Back Pressure	7.2 in. H ₂ O (17.5 kPa)

Amperage	
Rated Voltage	Maximum Amps
1Ø 120 Volt	155.4 Amps (4 wire) 168A x 2 (Zigzag)
1Ø 240 Volt	77.8 Amps (4 wire) 168A (Zigzag)
3Ø 240 Volt	168 Amps
3Ø 480 Volt	84 Amps
Main Line Circuit Breaker Rating	168 Amps
Over Current Relay Trip Set Point 480V Mode Only	84 Amps

WARRANTY*

Isuzu Engine**

12 months from date of purchase with unlimited hours or 36 months from date of purchase with 3,000 hours (whichever comes first).

Generator

24 months from date of purchase or 2,000 hours (whichever occurs first).

Trailer

12 months excluding normal wear items.

*Refer to the express written, one-year limited warranty sheet for additional information.

**Refer to Isuzu Diesel Engine Limited Warranty for details.

NOTICE

Specifications sheet is subject to change and is not intended for use in installation design.



DCA70SSIU4F

MQ POWER Series Generator

MQ POWER DECIBEL LEVELS

Our soundproof housing allows substantially lower operating noise levels than competitive designs. WhisperWatts are at home on construction sites, in residential neighborhoods, and at hospitals — just about anywhere.

- 90 — Subway / truck traffic
- 80 — Average city traffic
- 70 — Inside car at 60 mph
- 60 — Air conditioner at 20 feet
- 50 — Normal conversation

WhisperWatt at 23 feet



GENERATOR OUTPUT PANEL

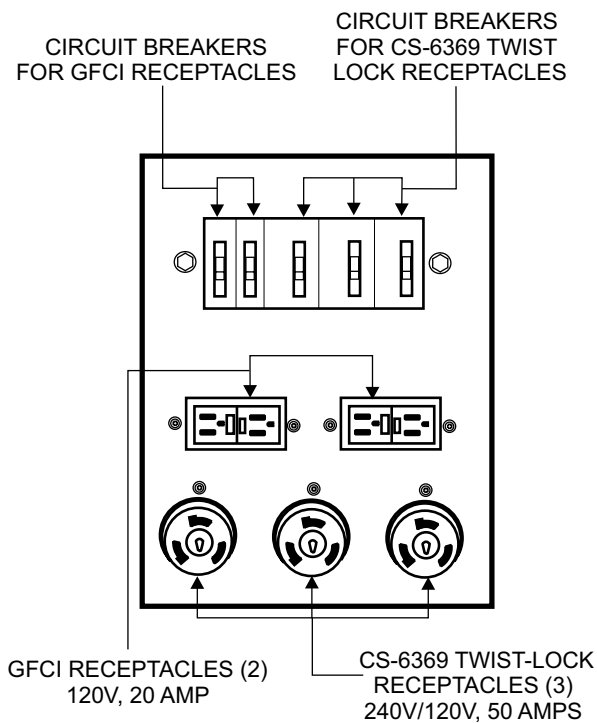

OPTIONAL GENERATOR FEATURES

- **PowerBalance™** — designed to assist generators when operating under low temperature and/or low load conditions to insure peak performance.
- **Battery Charger** — provides fully automatic and self-adjusting charging to the generator's battery system.
- **Jacket Water Heater** — for easy starting in cold weather climates.
- **Heavy-Duty Batteries** — long life batteries provide extra engine cranking power.
- **Spring Isolators** — provides extra vibration protection for standby applications.
- **Trailer Mounted Package** — meets National Highway Traffic Safety Administration (NHTSA) regulations. Trailer is equipped with electronic or surge brakes with double axle configuration.

OPTIONAL CONTROL FEATURES

- **Emergency Stop Switch** — when manually activated, shuts down generator in the event of an emergency.
- **Audible Alarm** — alerts operator of abnormal conditions.

OPTIONAL FUEL CELL FEATURES

- **Sub-base fuel cells (double wall)** — additional fuel cell for extended runtime operation. Contains a leak sensor, low fuel level switch, and a secondary containment tank. UL142 listed.
- **12 hours of minimum run time.**
- **24 hours of minimum run time.**

OPTIONAL OUTPUT CONNECTIONS

- **Cam-Lok Connectors** — provides quick disconnect alternative to bolt-on connectors.
- **Pin and Sleeve Connectors** — provides industry standard connectors for all voltage requirements.
- **Output Cable** — Available in any custom length and size configuration.



DCA70SSIU4F

MQ POWER Series Generator

DIMENSIONS

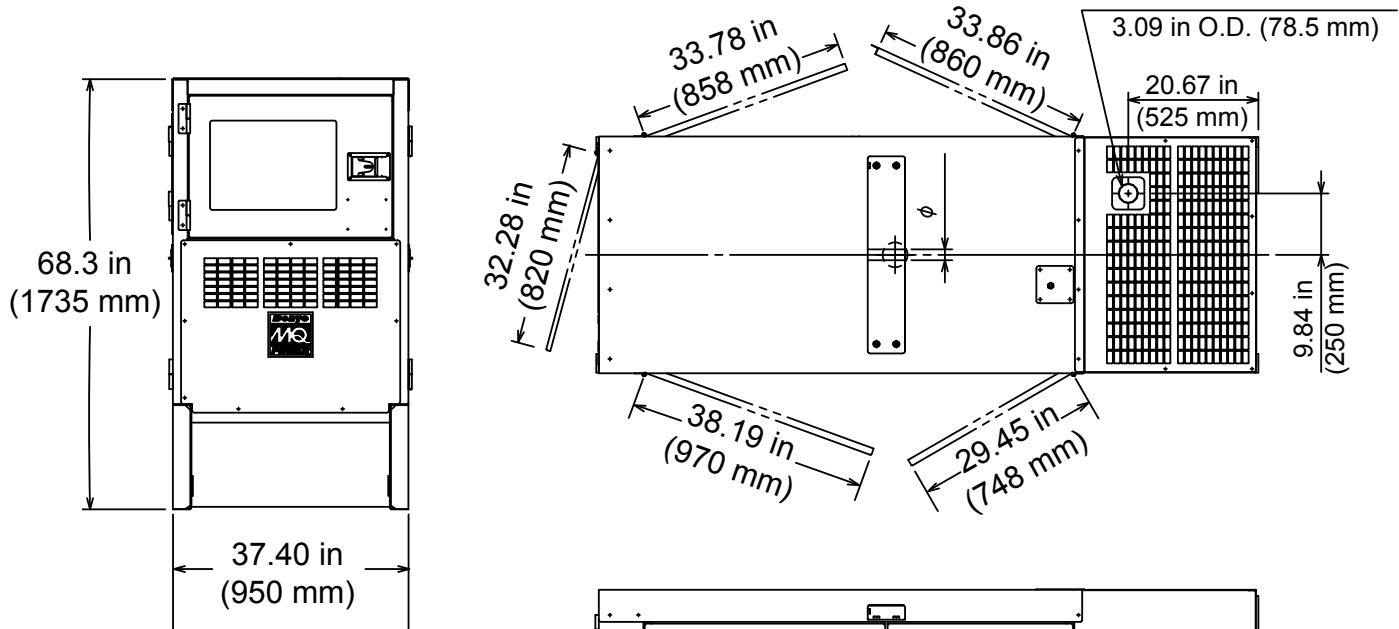

Weight	
Dry Weight	3,329 lbs. (1,510 kg)
Wet Weight	4,211 lbs. (1,910 kg)
Max. Lifting Point Capacity	6,960 lb. (3,157 kg)

NOTICE
Features and Specifications are subject to change without notice.

Generator can be placed on MQ Trailer Models TRLR70US and TRLR75XF2.

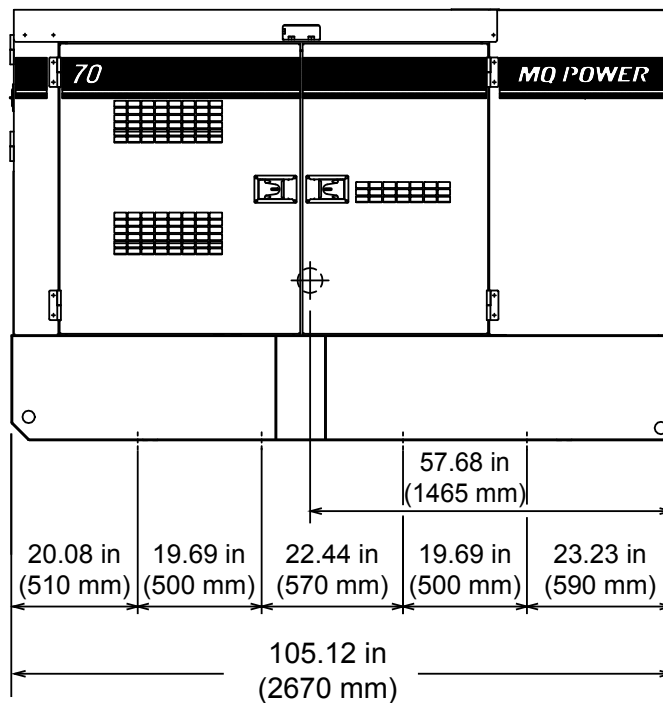

Manufactured by Denyo Co.

Your MultiQuip dealer is:

